

# Annotation, Model-Based Development & Mechanical Engineering Design Capabilities

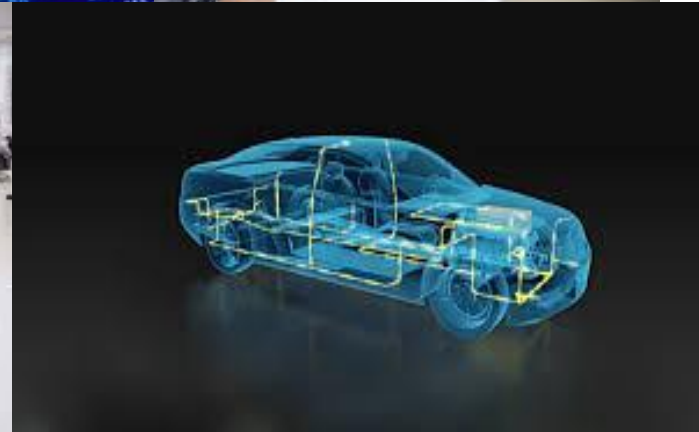
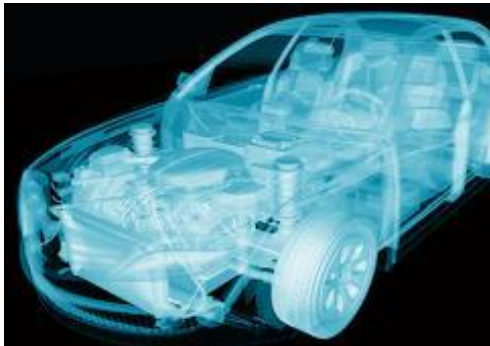

**Focus-Innovate-Expand & Differentiate**

# TechnoPro Group

Corporate Name	TechnoPro Holdings, Inc.
Business Outline	Technology-focused staffing and service companies with more than 25,000 engineers and researchers, with expertise in fields such as machinery, electrical/electronic engineering, information systems, chemistry, biotechnology, and energy
Head Office	35F, Roppongi Hills Mori Tower, Roppongi 6-10-1, Minato-ku, Tokyo, Japan
Established	April, 2012
Company CEO	Takeshi Yagi
Employees	25000+
Annual Sales	158.4 billion yen ≒ 1.5 billion USD
Branch Offices	127 sales offices Development Center : 27 Branches    Training Facilities : 63 Locations



**TechnoPro Holdings, Inc.  
Head Office**

# TechnoPro Overview : Established in June 1997

## Competitive Edge

- ✓ Listed on Tokyo Stock Exchange: **Market Cap of JPY 418 Billion**
- ✓ **Aim : Global Expansion** through **Organic and M&A Route**

### Market Leader

- **Market Leader with** 8% Market share in **Professional Services (Specialized Engineers)** in Japan
- Comprehensive Engineering Consulting footprint in Japan

### Diversified Client Base

- Over **2,200 clients** among well-diversified industries with Long Term Strategic relationships
- Top 10 Customers account for **13%** of total Sales; One of the best **Customer Diversification** in the Industry

### #1 Engineer Base with Best Recruiting Team

- Wide range of Technology offerings with over **25,000 engineers**
- Strong capability to recruit new engineers (nearly **4,300 new hires**)

### Management Capability Mitigates Bench Risk

- Over **95% Resource Utilization** by Robust & Structured management system – (All Engineers are engaged as as full-time employee)
- Established **Training & Educational capability** to improve engineer quality

# TechnoPro Global Customer Base

## Serving through 25 Years of different Industry

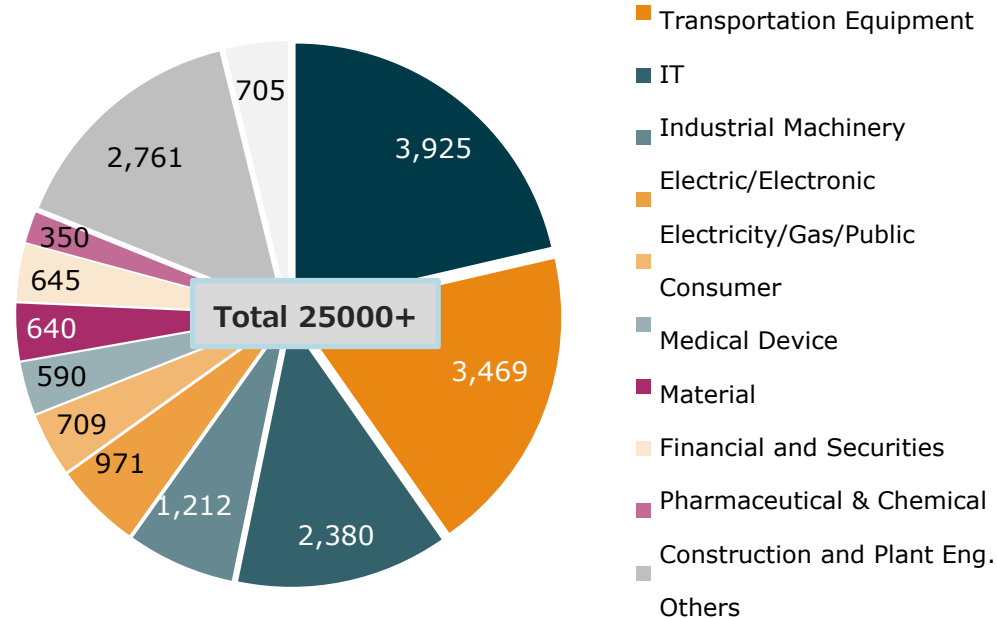

- # of clients is over **2,200** as of June 2022.
- Top 10 clients accounts for **13%** of total sales.

### TechnoPro India Customer(s):

## Trusted and Diversified Customers across Various Industry Sector

Transportation	IT	Telecom	Machinery	Electronic	Pharma And Chemical	Construction
   	    	 <small>Designing The Future</small>   	    	    	     	     

# Introduction of Services

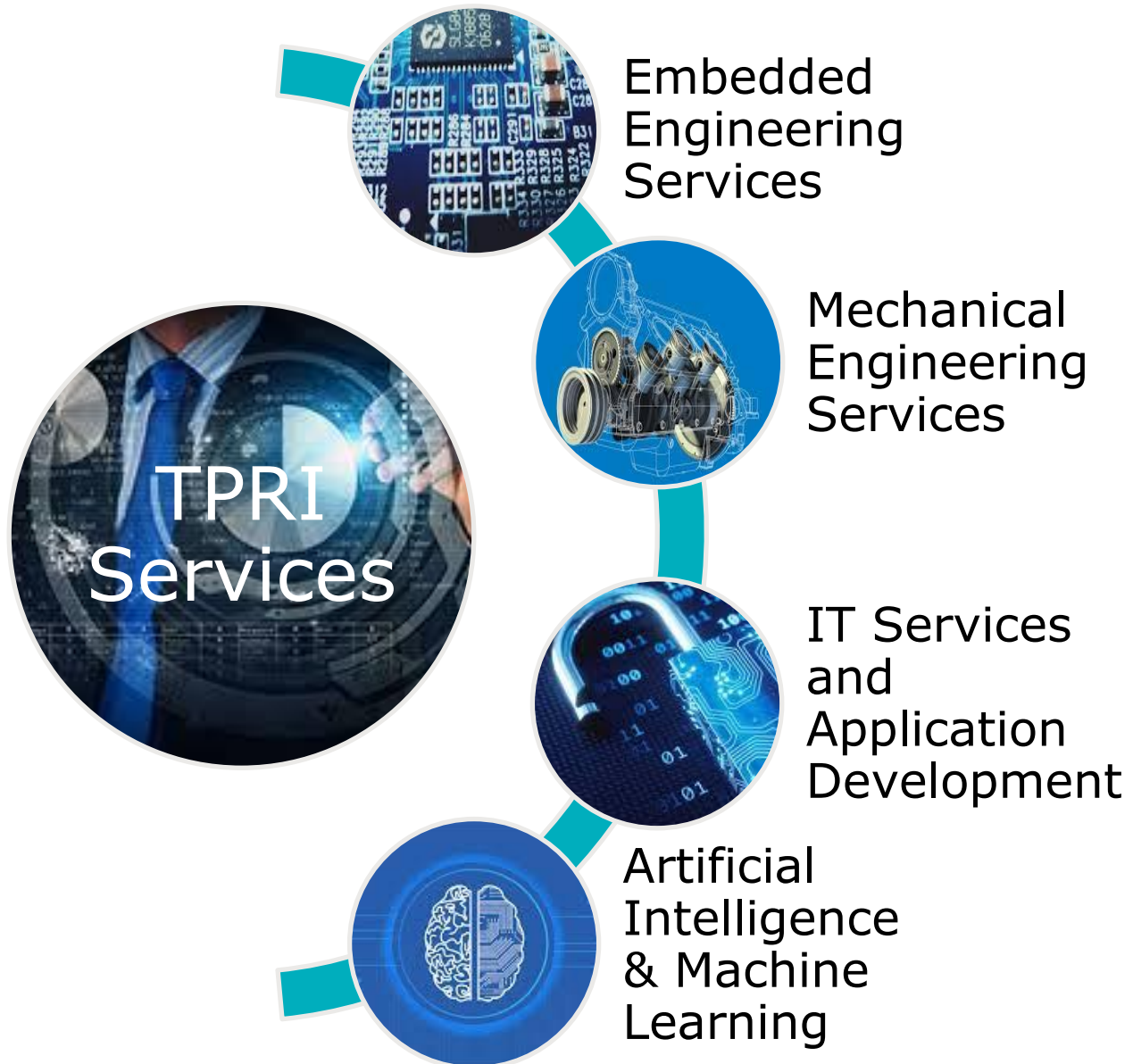

# Service Offerings

## Embedded Engineering Services

### Electric Mobility

- BMS
- Motor Controller
- DC/DC Converter

Model Based Development

Model Based Testing

## Mechanical Engineering Services

New Technology Development

Product development for Automotive

Sustaining & Manufacturing Engineering for Automotive

## IT Services and Application Development

Application Development & Maintenance

Rapid Control Prototyping

TAAS (Testing as a Service)

VAPT(Vulnerability and Penetration Testing)

## Artificial Intelligence & Machine Learning

Data Preparation: Collection and Cleansing

Signal and Image Processing

Feature Engineering & Annotation

Data Modeling & Optimization

# ANNOTATION

# Annotation Service offerings

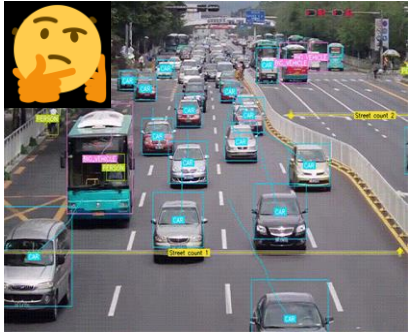

**Image annotation** is the labelling or tagging of objects such as person, car, road, traffic signs, etc. Image annotation is the foundation for many Artificial Intelligence (AI) products especially for computer vision process, where it entirely depends on the object that we have annotated to recognise them from the model, these images are tagged to train the computer and ask with computer for prediction by providing them unlabelled image.

With the increased availability of image data for companies pursuing AI, the number of projects relying on image annotation has grown exponentially. Creating a comprehensive, efficient image annotation process has become increasingly important for organizations working within this area of machine learning (ML).

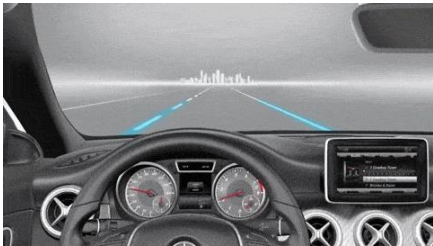

## Applications:

**Advanced driver assistance systems (ADAS), Healthcare, manufacturing, Industry 4.0**

Types of Image Annotations: 1) Classification, 2) Object Detection, 3) Semantic and Instance segmentation

**In object detection we have carried out Bounding box, Cuboid, polygon, poly-line and key points annotation. In segmentation we are well versed with Semantic and Instance segmentation**



# Annotation Service offerings

## 1. Bounding Box annotation for different type of cars using Label Box

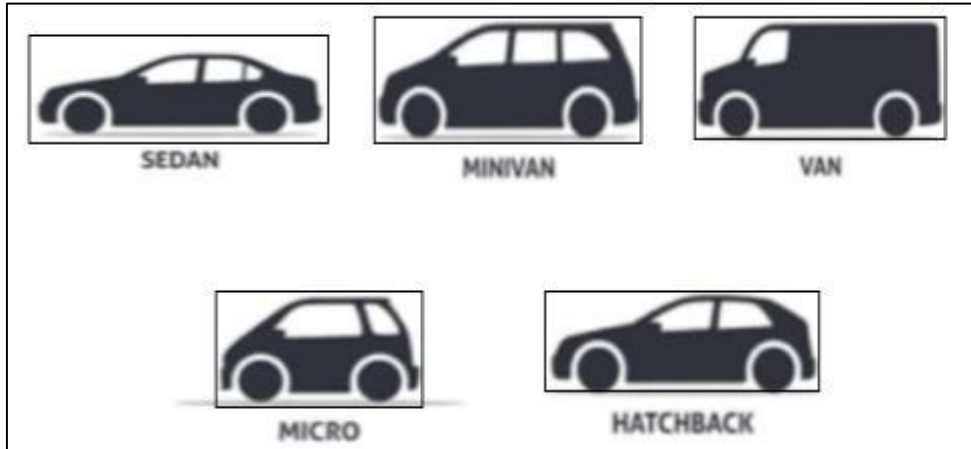

## 2. Bounding Box annotation for different sides of the cars using Label Box



## 3. Driver Behavior Annotation



## 4. Driver Face Monitoring Annotation



# Cont..

## 5. Identifying Traffic Signs as same / different



## 7. Annotation of Car Damaged Parts using Bounding Box with VoTT

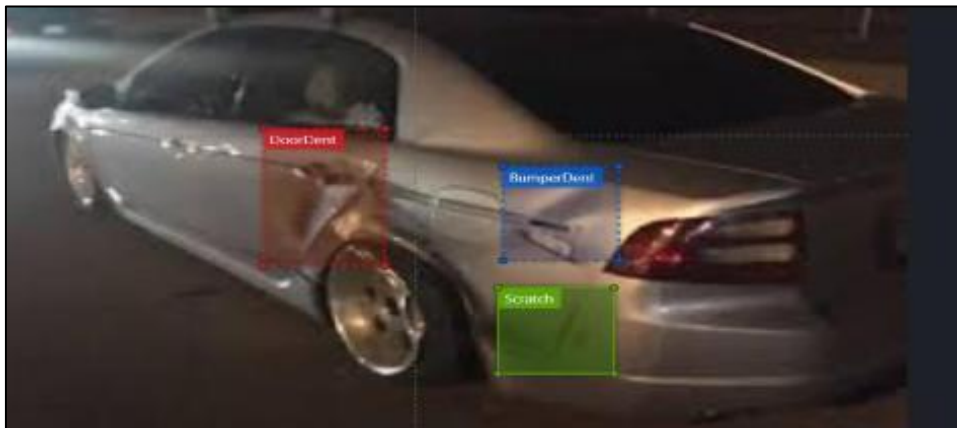

## 6. Annotation for car parts using Bounding Box

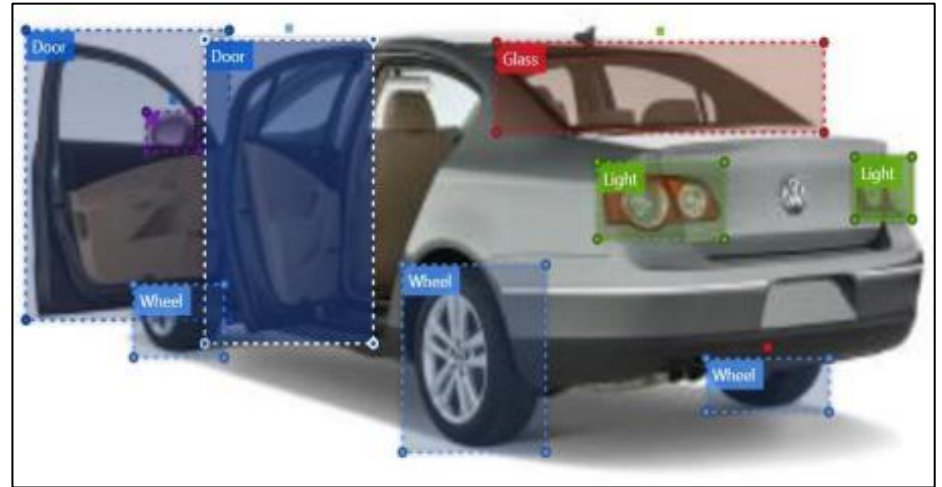

## 8. 2D Annotation Using Bounding Box with Playment tool



# Cont..

## 9. 2D Annotation for cars Bounding Box using Playment



## 10. Cuboid Annotation for Cars, road traffic signs using Playment



## 11. Polyline Annotation for person, cyclist, traffic signs using LabelBox



## 12. Polygon Annotation for cars using LabelBox



# Cont..

## 13. Landmark / Key Point Annotation for cars using playment tool

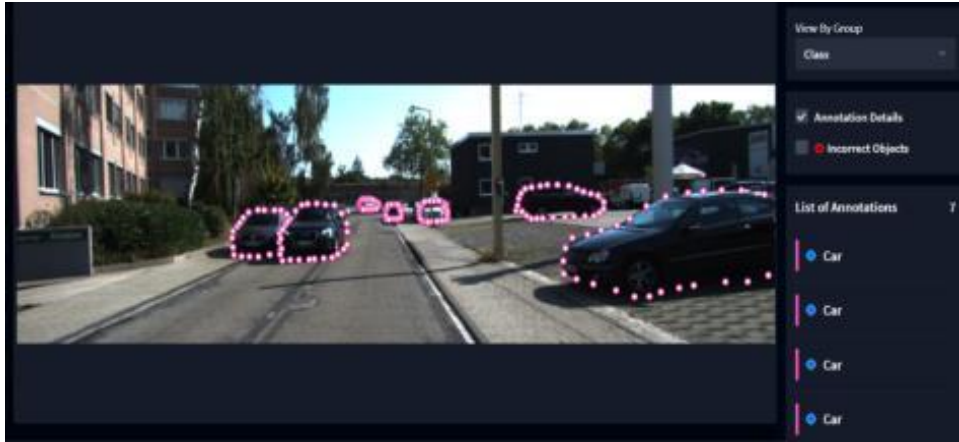

## 14. Incident Annotation Task

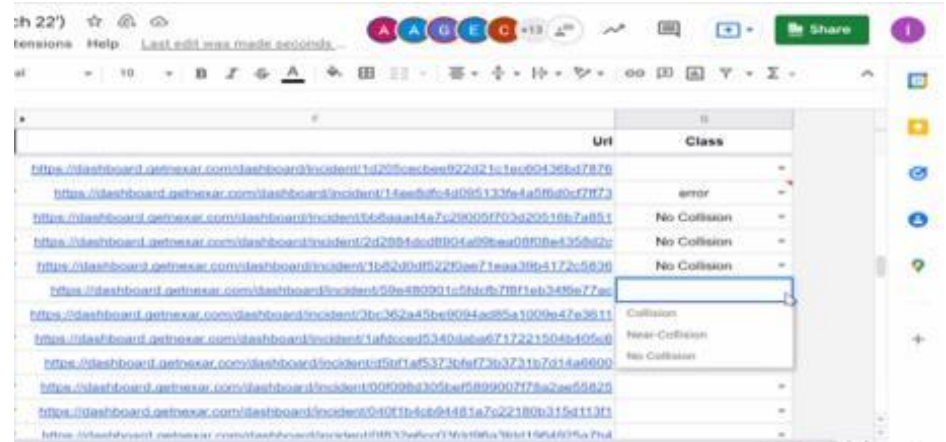

## 15. Manual & Semi-automatic Semantic and Instance annotations for cars, person using CVAT

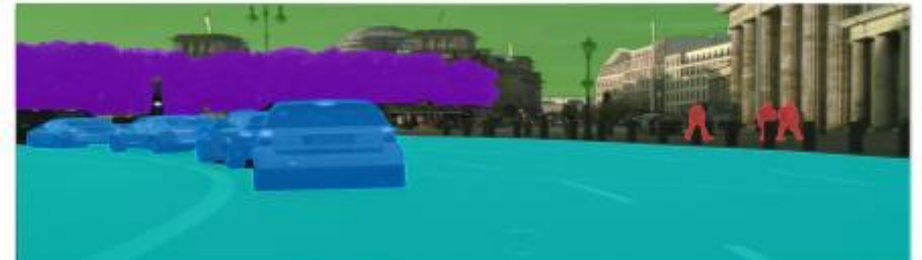

# Cont..

## 16. 3D annotation for cars, cyclist and person using Understand.AI and MATLAB

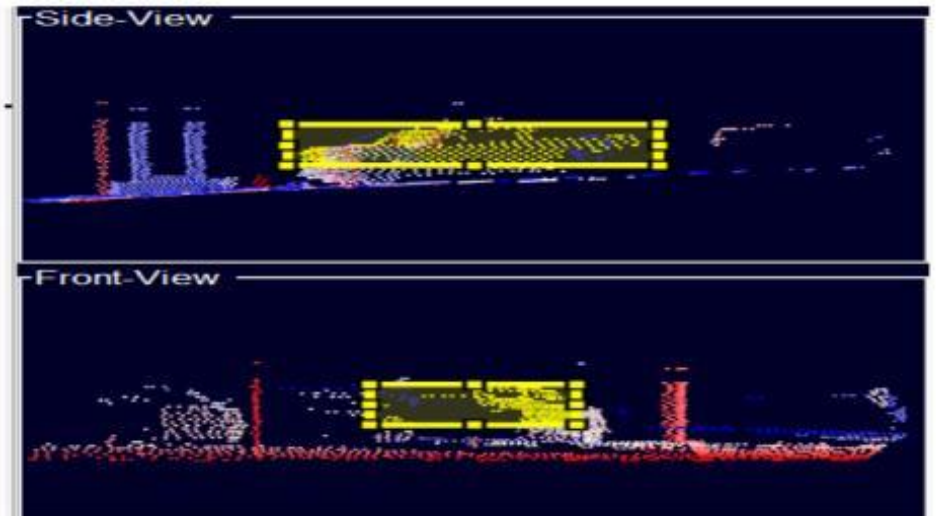
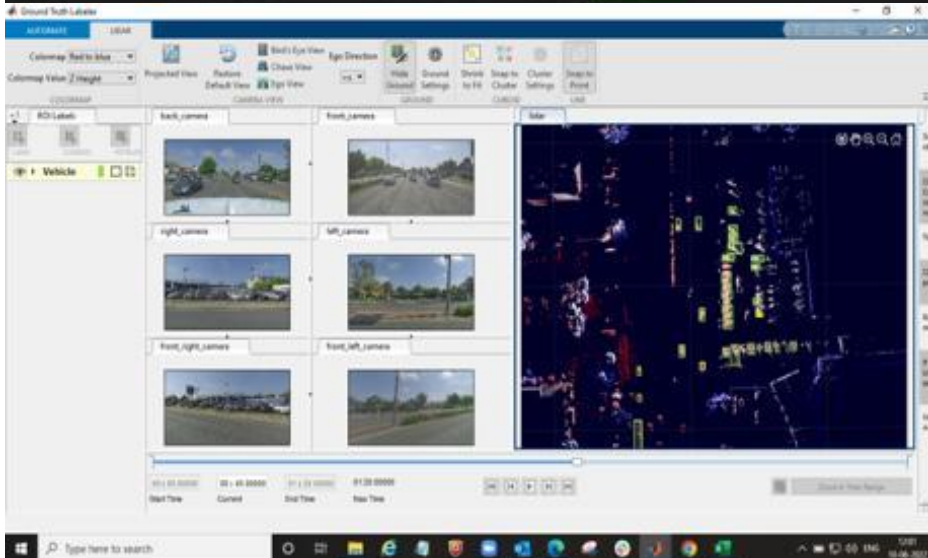
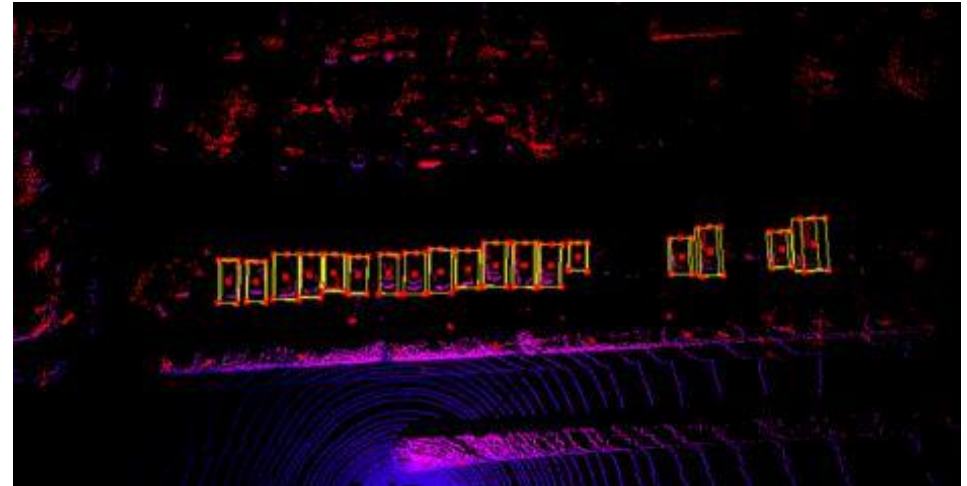
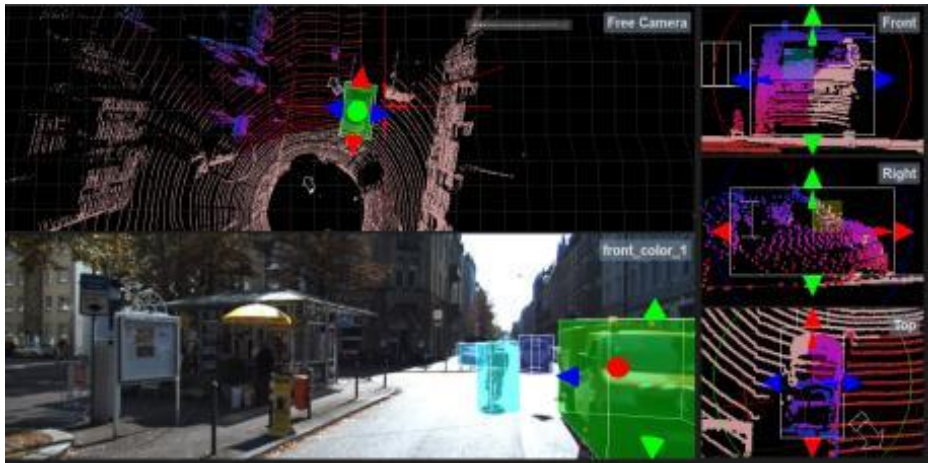

# Annotation capabilities and Team Structure

Io	Type of Annotations	Tool used
1	Bounding Box for car types	Label Box
2	Bounding Box for car sides	Label Box
3	Driver Behavior Annotation	Google Spread sheet
4	Driver Face Monitoring Annotation	LabelBox
5	Identifying Traffic Signs as Same/ Different	Google Spread sheet
6	Car Parts Annotation using Bounding Box	Vott
7	Car Damaged Parts Annotation using Bounding Box	Vott
8	2D Annotation Using Bounding Box for cars, cyclist, traffic light and road signal	Playment
9	Cuboid Annotation Task cars, cyclist, traffic light and road signal	Playment
10	Landmark / Key Point Annotation for cars, cyclist, traffic light and road signal	Playment
11	Polyline Annotation for cars, cyclist, traffic light and road signal	Label Box
12	Polygon Annotation for cars	Label Box
13	Image Segmentation Annotation for cars	Label Box
14	3D Annotation Task for cars, cyclist and person	Understand.AI
15	Semantic and Instance based Image Segmentation for all objects (Manual and Semi-Automatic)	SemaSeg/CVAT / Matlab
16	Incident Annotation for analyzing the video of a car	Google Spread sheet
17	Semi Automated Annotation for cars	CVAT

# MODEL BASED DEVELOPMENT MODEL BASED TESTING

# Software Development Process: V-model

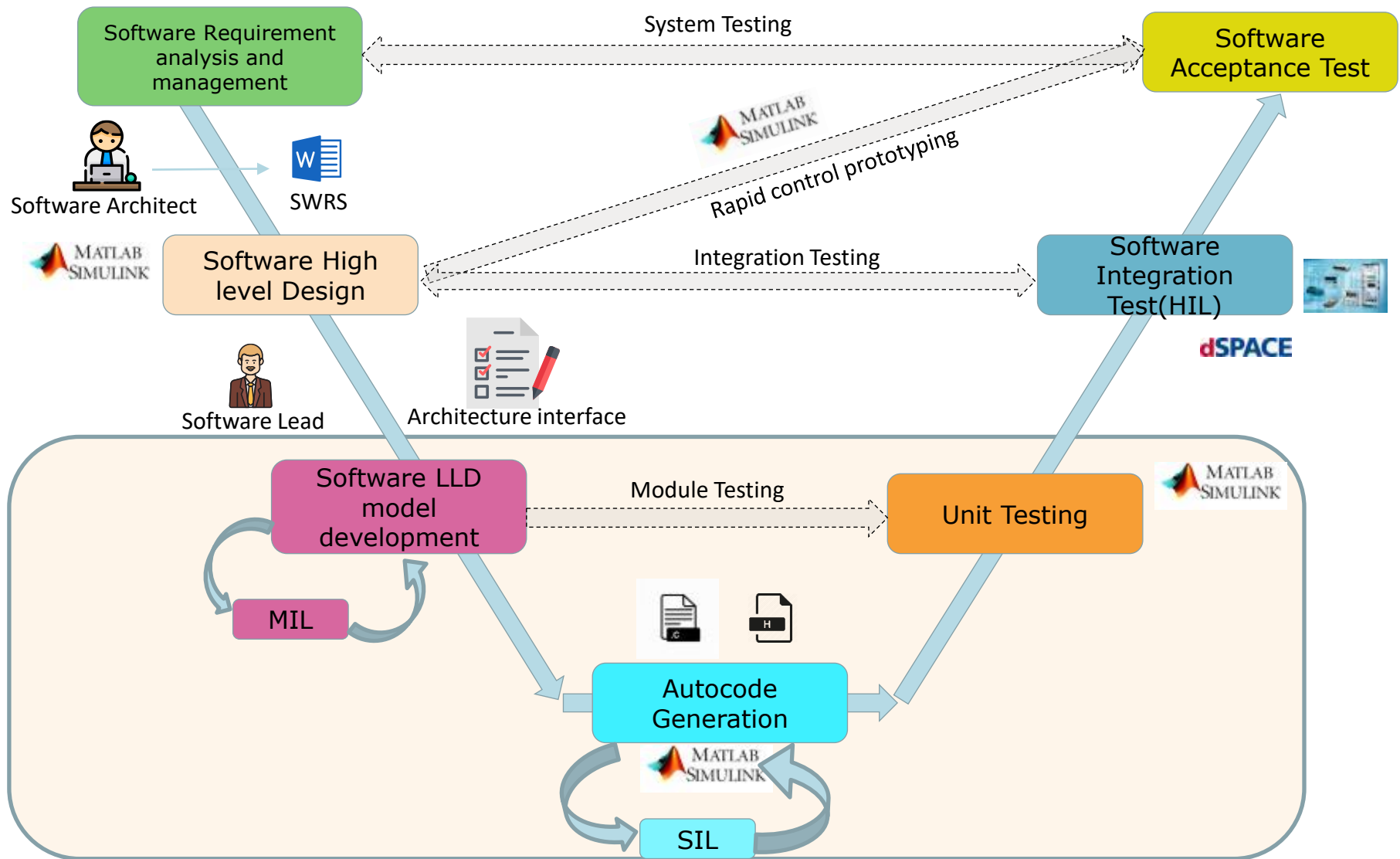



# Model Based Development Services

## Model Based Development Services

- Model Development
- MAAB Guideline Check(Model Advisor)
- AutoCode Generation using Embedded Coder
- Static Code Analysis using Polyspace

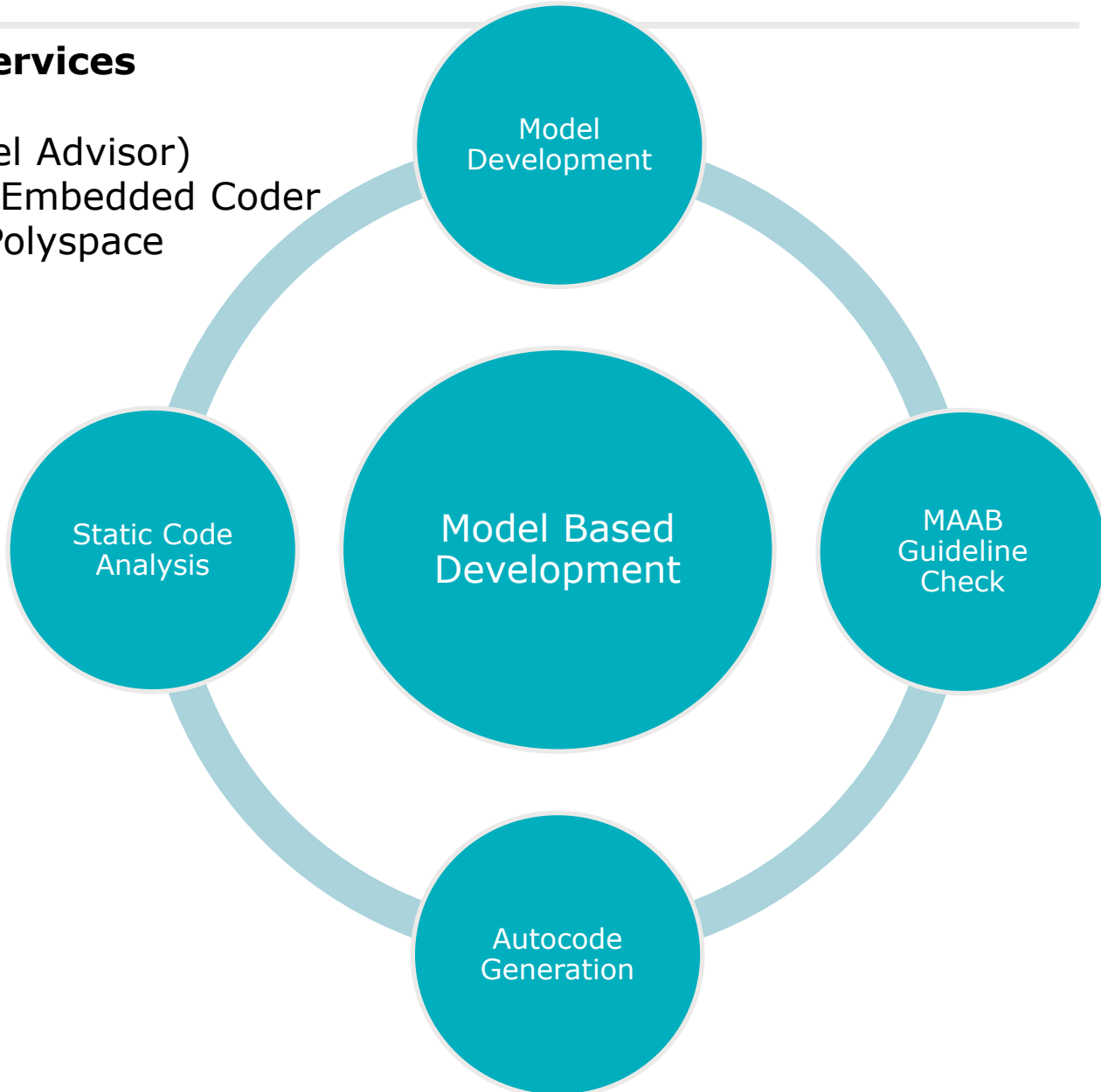

# Model Based Development Services

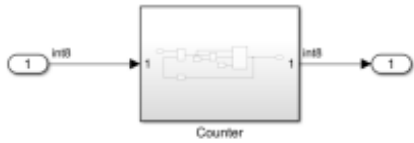

## Model Development Services

- Customer Input Analysis
- All the supporting documents
- Start Model Development



## MAB Guideline Check Services

- MAB Guideline Check
- MAB Guideline Report

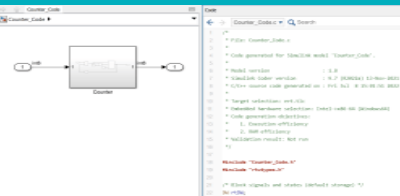

## Autocode Generation Services

- Model files as input for Autocode Generation
- Autocode Generation using Embedded Coder



## Static Code Analysis Services

- Static Code Analysis using Polyspace
- Polyspace Reports

# Model Based Testing Services

## Model Based Testing Services

- Requirement Based Testing
- Automatic Test Case Generation
- Model-In-Loop(MIL) Testing
- Software-In-Loop(SIL)Testing

### Software-In-Loop(SIL)Testing

- Check the Behavior of MIL vs SIL, If any differences.
- Validating the Code against Test cases( functional and Coverage Testing).

Software-In-Loop (SIL) Testing

### Model-In-Loop(MIL) Testing

- Checking the Model Behavior with software Requirement.
- Validating the Model against Test cases( functional and Coverage Testing).

Requirement Based Testing

### Requirement Based Testing on Simulink Model

- The Requirement Based testing is similar to functional testing.
- Writing the functional test cases based on the Requirement provided by the customer.
- Software Requirement Documents are inputs to write the Test cases.

Model Based Testing

Automatic Test Case Generation

### Automatic Test Case Generation

- Automatically generating the test cases based on model and Supporting files using the Reactis Tools.
- After Test cases are generated and export .CSV file to write additional test cases to cover 100% MCDC Coverage.

Model-In-Loop (MIL) Testing

# Model Based Testing Services

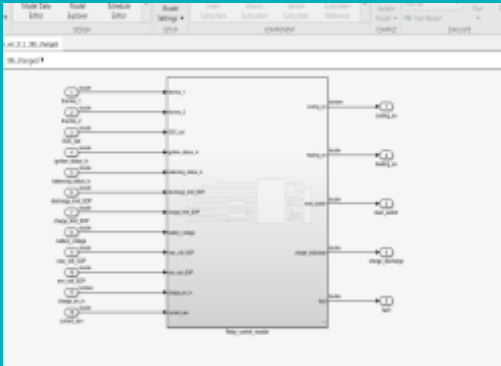

## Model-In-Loop(MIL) Testing

- Check all the inputs for MIL Testing
- Develop test cases for MIL Testing
- Checking the Model Behavior with software Requirement
- Validating the Model against Test cases

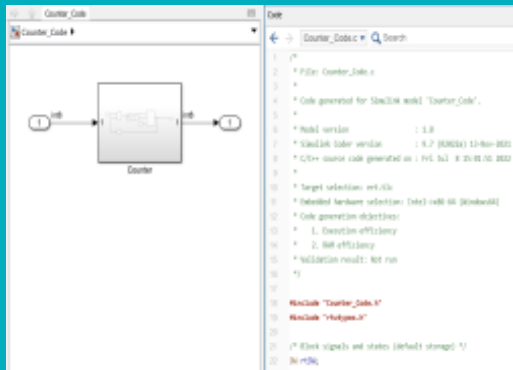

## Software-In-Loop(SIL) Testing

- Reuse the test cases from MIL to SIL Testing
- Check the Behavior of MIL vs SIL, If any differences
- Validating the Code against Test cases

# Battery Management System (BMS) Services

## Algorithm Development

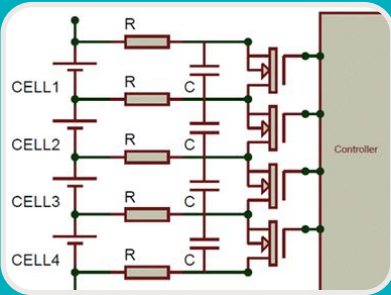

- Requirements gathering and system design Development.
- Model Based Development in MATLAB/Simulink/Stateflow.
- MAAB Guideline Check
- Auto code Generation using Embedded Coder
- Static Code Analysis using Polyspace
- Custom Stack Development.

## Algorithm Testing



- Automatic Test case generation or Manual Test case writing
- For Coverage and Functional Testing
- Model In Loop (MIL) Testing and Software In Loop (SIL) testing
- Customer's algorithm testing

## Embedded Engineering: BMS



- System architecture Design
- Software architecture Design
- Software Requirement Document Design.

# Reference Block Diagram of BMS

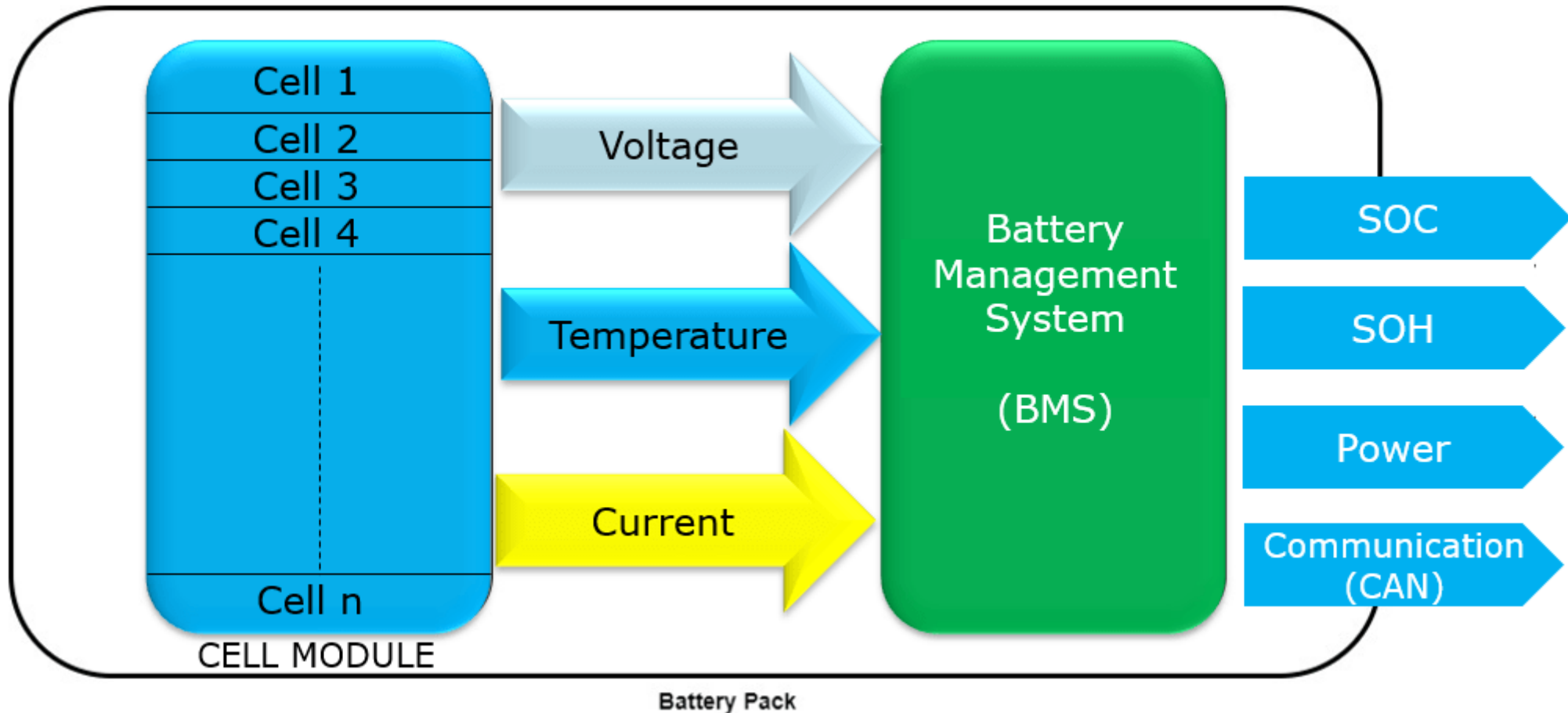

# Case Study- Model Based Development and Testing

## Model Based Development for EPS (Electric Power Steering)

### Requirement Analysis

- Input Requirement Analysis

### Model Development

- Model Based Development using MATLAB, Simulink, Stateflow, Targetlink
- Automatic Code Generation(TargetLink)
- Unit-Component Design Document Creation

### SWC Test Specification Creation

- SWC Test Specification Creating a functional perspective.
- Functional/structural test (SIL - Test specification creation only)- BTC Embedded Tester.

### Static Code Analysis using Polyspace

- Static Code Analysis (Polyspace BF/CP)

# MECHANICAL ENGINEERING



# Mechanical Engineering



## New Technology Development

- Market Research
- New Technology Development
- Concept Development using CATIA, Pro-e, UGNX & Auto cad
- Computer aided engineering (CAE) support
- Continuous Improvement

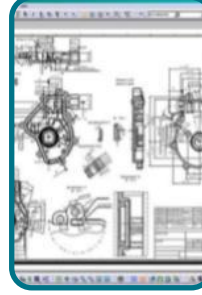

## Sustaining Engineering

- Existing Design Updation
- Existing Drawing Updation
- CR/CO Management
- PLM & PDM Support



## New Product Development

- Concept Development using CATIA, Pro-e, UGNX & Auto cad
- Drawing creation, GD&T Allocation,
- Tolerance Stack up Analysis
- Product costing
- Computer aided engineering (CAE) support



## Tool Design

- Moulding tool design & Drawing
- Casting tool design & Drawing
- Machining tool design & Drawing
- Jigs and Fixture Detailing and Designing
- Computer aided engineering (CAE) support

# TPRI Current Mechanical Engineering Capabilities

## Tool proficiency

- **CATIA V5**



- **SOLID WORKS**



- **UG NX**



- **PLM ENOVIA**



- **TEAMCENTER**



- **AUTOCAD**

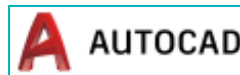

# TPRI – OEM Mechanical Engineering overview

Following activities are performed by our engineers in OEM

BIW Jigs and Fixture Design

Creating manufacturing drawing with allocation of GD&T

Design support for Trim & Chassis

Designing of normal Fixtures, SPM, Pallet

Machine Maintenance

Process layout design

Equipment Selection

Preparing BOM

PLC programming and Robotic trouble shooting

Imitation and reinforcement learning

Electronics and electrical support

Robot Cell & Transfer system

Control Panel Wiring

PLC Programming

# TPRI – Tier 1 Auto Mechanical Engineering overview

Following activities are performed by our engineers in Tier 1 Auto

Maintenance of following machines - Microsmatic Cylindrical & Angular Grinding, J-teck Honing and EFD Induction Hardening Machine, Grind master Paper lapping machine.

Design & development of different clamping equipment model and its 2D drawings.

Design and development of sheet metal parts using Catia

Document creation and updating of new product and change request

Piping and hose routing

Existing Part & drawing update

Managing Bill of material (BOM)

Product life cycle management using PLM tool - Enovia

# Case Study:- Design Capabilities

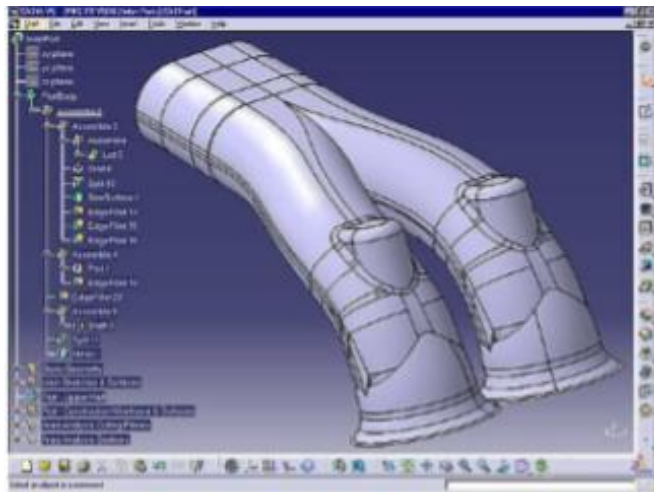

Part Design

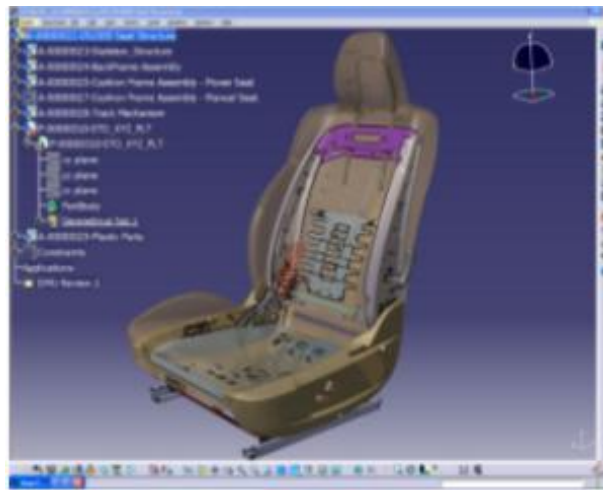

Assembly Design

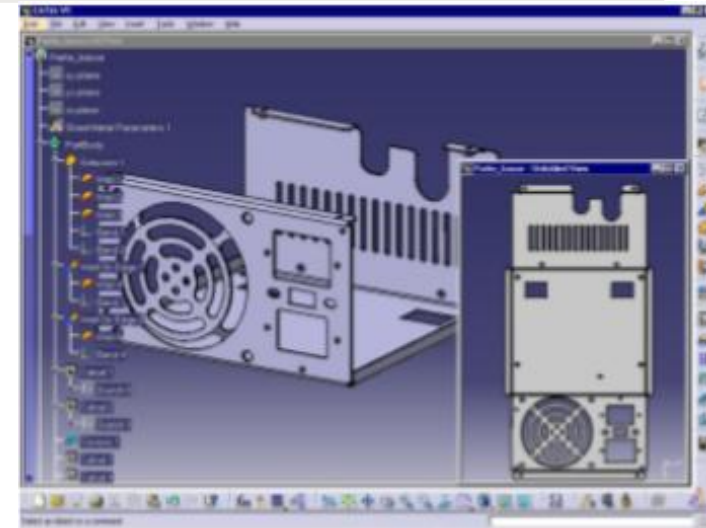

Sheetmetal design

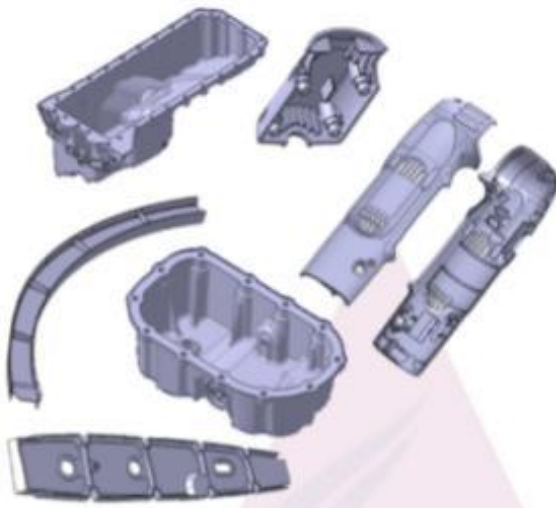

Functional molded parts

TECHNOPRO

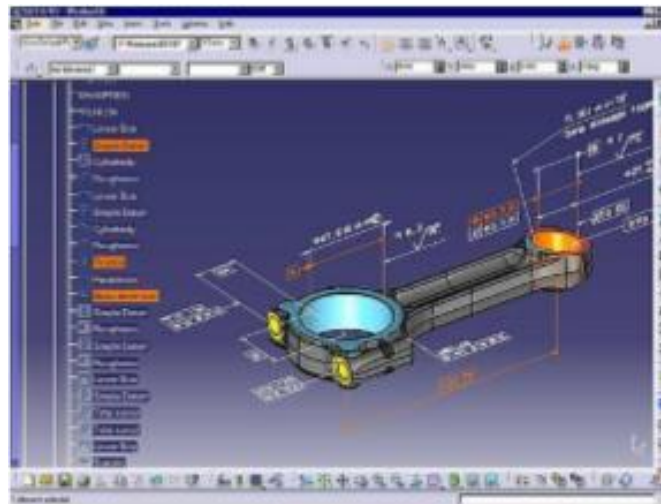

Functional tolerancing & annotation

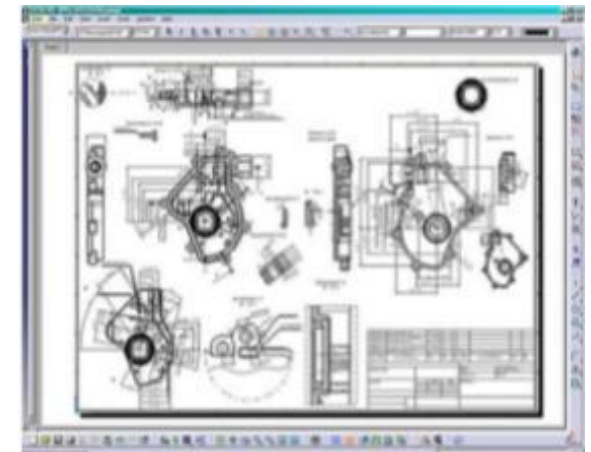

CATIA -Drafting

# TECHNOPRO



For more details:  
+972-97456240  
[Sales@electrosafe.co.il](mailto:Sales@electrosafe.co.il)

